

lapalma

mak

design patrick norguet
2012

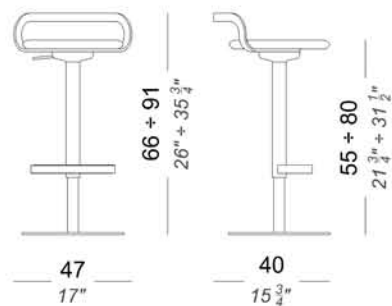



Sgabello girevole ad altezza variabile con molla a gas. Struttura e base in acciaio verniciato a polveri epossidiche. Sedile imbottito e rivestito in tessuto o pelle.

Stool with swivel seat and adjustable height with gas-spring. Frame and base in epoxy lacquered steel. Upholstered seat with fire-retardant foam covered with soft leather or fabric.

 13 kg
 0





Base rivestita in acciaio
inox Aisi 304 con feltri ade-
sivi in lana.

*Aisi 304 stainless steel
base with wool felt*



Bloccetto di unione sedile/colonna in alluminio pressofuso
sabbato e comando della molla a gas in acciaio inox.

*Pivot under the seating in die-cast aluminium and operating
lever in stainless steel*

finiture / finishes

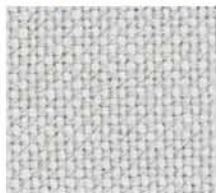
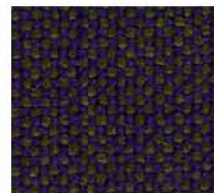
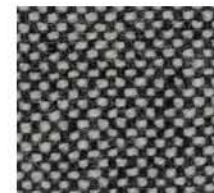
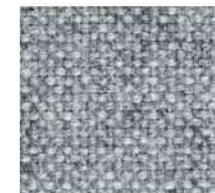
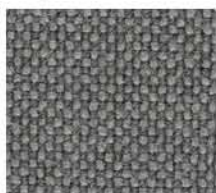
tessuto Hallingdal 103
Hallingdal fabric 103tessuto Hallingdal 224
Hallingdal fabric 224tessuto Hallingdal 674
Hallingdal fabric 674tessuto Hallingdal 960
Hallingdal fabric 960tessuto Hallingdal 968
Hallingdal fabric 968tessuto Hallingdal 702
Hallingdal fabric 702tessuto Hallingdal 126
Hallingdal fabric 126tessuto Hallingdal 130
Hallingdal fabric 130tessuto Hallingdal 153
Hallingdal fabric 153tessuto Steelcut 110
Steelcut fabric 110tessuto Steelcut 240
Steelcut fabric 240tessuto Steelcut 435
Steelcut fabric 435tessuto Steelcut 535
Steelcut fabric 535tessuto Steelcut 615
Steelcut fabric 615tessuto Steelcut 950
Steelcut fabric 950tessuto Steelcut 980
Steelcut fabric 980tessuto Steelcut 780
Steelcut fabric 780tessuto Steelcut 685
Steelcut fabric 685tessuto Steelcut 180
Steelcut fabric 180tessuto Steelcut 370
Steelcut fabric 370tessuto Steelcut 190
Steelcut fabric 190

finiture / finishes

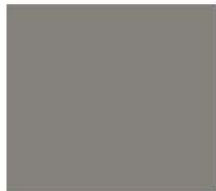
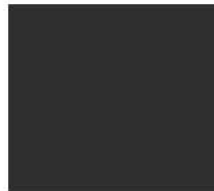
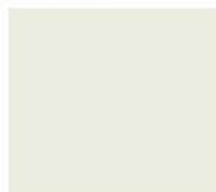
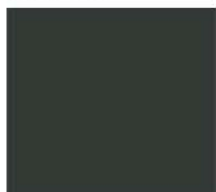
pelle bianca
white soft leatherpelle grigio
grey soft leatherpelle fango
mud soft leatherpelle marrone scuro
dark brown soft leatherpelle nera
black soft leatherverniciato bianco
white lacqueredverniciato nero
black lacquered



ISTRUZIONI D'USO E MANUTENZIONE

Pulire tutte le parti in legno, cuoio, tessuto e metallo con un panno umido, o con detergente liquido neutro diluito.

Non usare prodotti a base alcolica, candeggina, solvente o prodotti abrasivi.

Liquidi versati sul prodotto devono essere asciugati subito.

Per sollevare e spostare il prodotto non afferrare solo il sedile, bensì afferrare saldamente la struttura.

Il prodotto non deve essere sottoposto a carichi decentrati, è stato progettato per essere utilizzato in condizioni normali di appoggio (su quattro gambe o sulla base). L'azienda si solleva da ogni responsabilità per eventuali danni provocati su pavimenti delicati o teneri.

Evitare l'uso improprio del prodotto: non salire sul prodotto con i piedi, nè sul poggiatesta o sui braccioli. In particolar modo evitare oscillazioni che potrebbero pregiudicare il funzionamento e la sicurezza dell'utente.

Il legno ed il cuoio sono, per loro natura, facilmente danneggiabili, alcune piccole impurità e imperfezioni rientrano negli standard di qualità accettati.

Non esporre alle intemperie, agli agenti atmosferici né a fonti di calore superiori a 40°C. I prodotti destinati all'uso esterno subiscono comunque nel tempo l'azione degli agenti atmosferici. Eventuali alterazioni superficiali possono verificarsi a specifiche condizioni di esposizione di temperatura, umidità e salinità. Una corretta e frequente manutenzione e pulizia aumentano la durabilità del prodotto.

Il prodotto se è esposto alla luce del sole può essere soggetto a variazioni di colore.

Interventi di manutenzione devono essere eseguiti da personale esperto.

Smaltire l'imballo solo a completamento dell'assemblaggio, onde evitare lo smarrimento di eventuale ferramenta e componenti.

Una volta dimesso, il prodotto od i suoi componenti vanno conferiti ai sistemi pubblici di smaltimento secondo quanto previsto dalla legislazione in vigore.

USE AND MAINTENANCE INSTRUCTIONS

Clean all parts in wood, leather, fabric and metal with a damp cloth or a diluted neutral cleaner.

Do not use cleaners with alcohol, bleach, solvent or abrasive products.

Any liquid spilt on the product must be wiped up immediately.

When lifting or moving the product, hold it on the structure and not under the seat.

The product should not be subjected to unbalanced weights, as it is designed for a proper rest on the foothold (on four legs or on the base). Our company relieves from any responsibility in case of damage caused to fragile floors.

Avoid any improper use of the product: do not step on the product, on the footrest or on the armrests. Avoid any movements that could compromise the proper functionality of the product or the safety of the users.

Wood and leather, being natural materials, could be easily damaged. Small impurities or imperfections are within quality standard range.

Do not expose the product to weather conditions or atmospheric agents, nor to heat sources over 40°C. Also products for outdoor use could be afflicted by atmospheric agents. The product could undergo possible exterior changes due to particular exposure to heat, humidity and saltiness. An appropriate and frequent maintenance and cleaning of the product enhances its durability.

The product could change colour and shade, if exposed to direct sunlight.

Maintenance has to be carried out by experienced staff.

Dispose of the package only after assembling the product, in order to avoid the loss of ironmongery and components.

Once the product has been dismantled, the product itself or its components must be given to the public garbage disposal system, according to the legislation in force.