

	ONE EIGHTY Suspension	
	small	large
mm		
kg	0,8	1,0
	 max. 60 W/E14	 max. 150 W/E27
!		 
	CE	CE

# ONE EIGHTY SUSPENSION

serien  
.lighting

serien Raumleuchten GmbH Hainhäuser Str. 3-7 D-63110 Rodgau



Design Yaacov Kaufman

**D** Vor Montage der Leuchte Sicherung ausschalten!

**GB** Disconnect fuse prior to installation!

**F** Pour la pose de luminaire, couper le courant!

**I** Assicurarasi che la lampada si spenta prima del montaggio!

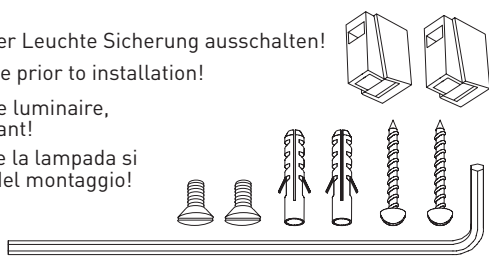

**A**

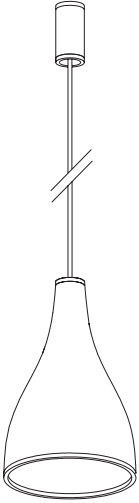

**B**

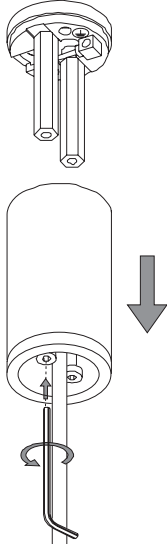

**C** (excl. backplate)

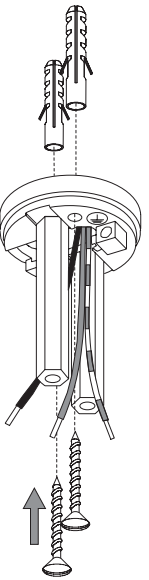

**C** (incl. backplate)

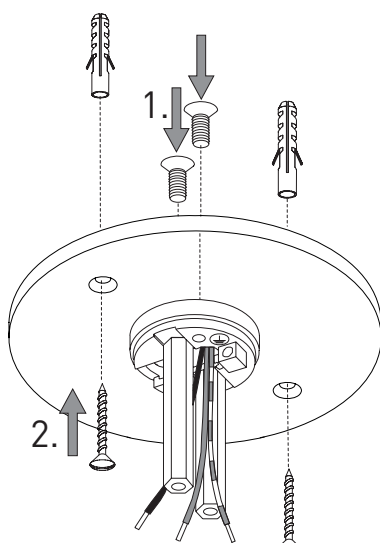

**D**

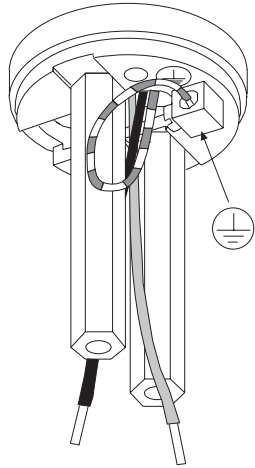

**E**

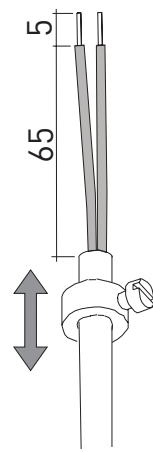

**F**

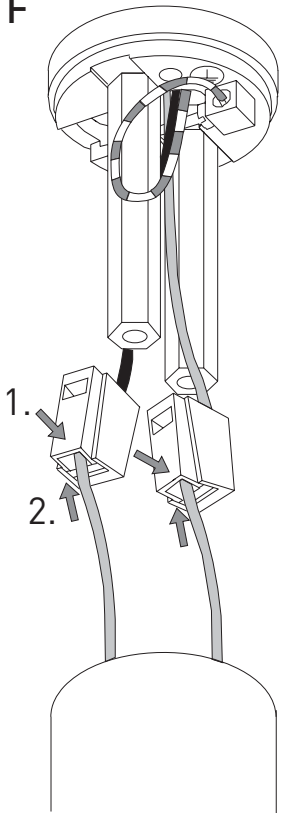

**G**

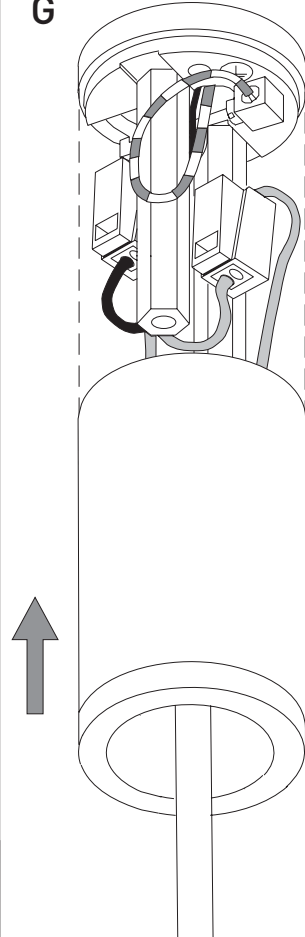

open  
open  
ouvert  
aperto



zu  
closed  
fermé  
chiuso



**H**

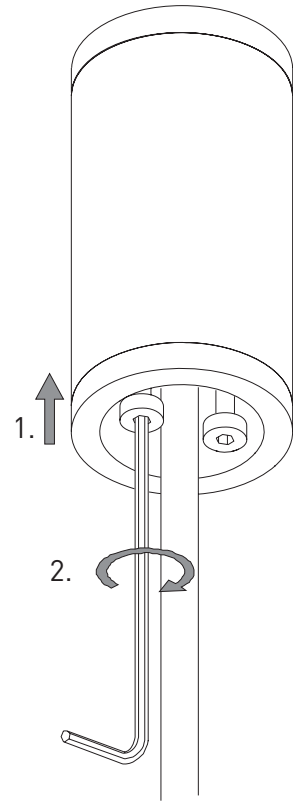

**I**

