



AXO[®] 2011-2012
LIGHT

AX20

MANUEL VIVIAN

Collezione completa di lampade in ottone e ferro finiti cromo con regolazione direzionale del fascio luminoso.

Complete lamp collection made of brass and iron with a chrome-plated finish. The direction of the light beam can be manually adjusted.

Komplette Leuchtenkollektion, Grundmaterial bestehend aus verchromten Messing und Eisen. Dimmbare Lichtregulierung.

Collection complète de lampes en laiton et fer finition chrome avec réglage directionnel du flux lumineux.

Colección completa de lámparas de latón y hierro con acabados de cromo y con regulación direccional del haz luminoso.

Коллекция светильников из хромированных латуни и железа, с регулированием направления светового потока.









< AP AX20 PI / SP AX20 PI
« PG 167: PT AX20





^ AP AX20 PI / LT AX20
< AP AX20 GR



























^ SP AX20 PI (DETAIL)
> SP AX20 B2



TECHNICAL DATA





-  E27 incandescent
-  E14 incandescent
-  E14 incandescent
-  E27 fluorescent
-  E27 fluorescent globe
-  E27 fluorescent twist
-  E14 fluorescent
-  E14 fluorescent
-  E14 fluorescent
-  E27 fluorescent
-  GX24q-2 fluorescent
-  2GX13 fluorescent
-  2G11 fluorescent
-  G5 fluorescent
-  G24d-2 fluorescent
-  G9 halogen
-  E27 halogen
-  G4 halogen
-  GY 6.35 halogen
-  GU4 halogen
-  GU5.3 halogen
-  GU10 halogen
-  E14 halogen
-  G53 halogen
-  R7s halogen

I nostri prodotti sono tutti sottoposti alle prove di sicurezza elettrica e conformi alle Direttive Comunitarie Europee EN60598-1, LVD 2006/95/EC, EMC 2004/108/EC (ove previsto).

All our products undergo electric safety tests and comply with ECC Directive EN60598-1, LVD 2006/95/EC, EMC 2004/108/EC (where provided).

Entsprechend den Europäischen Normen EN60598-1, LVD 2006/95/EC, EMC 2004/108/EC (sofern vorgesehen), werden alle Produkte den elektrischen Sicherheitsprüfungen unterzogen.

Tous nos produits sont soumis aux tests de sécurité, et sont conformes aux Directives CEE EN60598-1, LVD 2006/95/EC, EMC 2004/108/EC (le cas échéant).

Todos nuestros productos han sido sometidos a las pruebas de seguridad eléctrica y son conformes con las directivas comunitarias europeas EN60598-1, LVD 2006/95/EC, EMC 2004/108/EC (en los casos previstos).

Все наши изделия проходят испытания на электрическую безопасность и соответствуют директивам Европейского Сообщества EN60598-1, LVD 2006/95/EC, EMC 2004/108/EC (в случаях, когда это предусмотрено).



Solo isolamento fondamentale; le parti conduttrici accessibili sono collegate ad un conduttore di terra. Messa a terra obbligatoria.

Basic insulation, accessible conductors are earthed. Earthing is compulsory.

Grundisolation: berührbare Metallteile mit Anschlussstelle für Schutzleiter verbunden. Netzschutzleiter: vorgeschrieben.

Isolation de base: les parties conductrices accessibles sont mises à terre. Mise à terre obligatoire.

Solo aislamiento fundamental; las partes conductoras accesibles están conectadas a un conductor de tierra. Puesta a tierra obligatoria.

Изоляция только базовая. Доступные проводниковые части подсоединены к заземлителю. Заземление обязательно.



Sistema a doppio isolamento;
messa a terra esclusa.

Double insulation. Earthing:
excluded.

Doppelte Isolierung.
Netzschutzleiter: nicht erlaubt.

Double isolation. Mise à la terre:
exclue.

Sistema de doble aislamiento;
puesta a tierra no incluida.

Система двойной изоляции.
Заземление необязательно.



Apparecchio in cui la protezione
contro la scossa elettrica si basa
sulla alimentazione a bassissima
tensione di sicurezza.

Appliance in which protection
against electrical shock is
guaranteed by the extremely
low-voltage power supply.

Zum Schutz vor elektrischen
Schlägen mit Niedervolt Gespeistes
Gerät.

Appareil avec protection contre
les décharges électriques basée
sur l'alimentation à une tension
de sécurité très basse.

Aparado en el qual la protecció
contra la descarga eléctrica se debe
a la alimentació a muy baja
tensió.

Прибор, в котором защита от удара
током основана на питании от
очень низкого напряжения.



Predisposto con variatore di luce.

With dimmer.

Mit Dimmer.

Avec dimmer.

Con dimmer.

Предусмотрено с диммер.

Le schede tecniche dei prodotti
Axo Light sono scaricabili
direttamente dal nostro sito.

Axo Light technical sheets
can be directly downloaded from
our website.

Les fiches techniques des produits
Axo Light peuvent être téléchargés
directement de notre site.

Las fichas técnicas de producto
Axo Light se pueden descargar
directamente de nuestro sitio.

Die Axo Light Produktdatenblätter
können direkt von unserer Website
heruntergeladen werden.

Технические характеристики
изделий фирмы Axo Light
возможно скачать с нашего сайта.

SP AU 60/2

base / bulb type E27 halogen
 power 2 x max 250 w
 ilcos HSGST/C/UB 
 marks CE ⊕

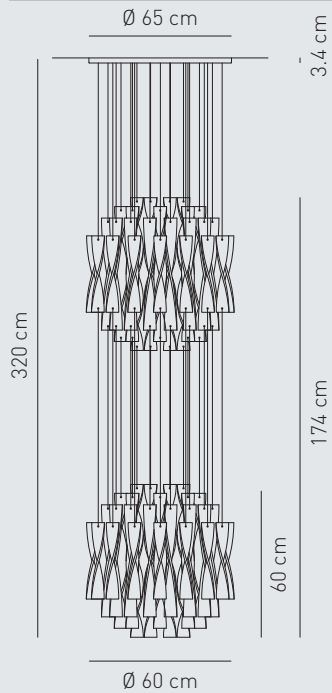

AX20 CHROME-PLATED FINISHINGS

AP AX20 PI

base / bulb type G9 halogen
 power 1 x max 60 w
 ilcos HSGST/C/UB 
 marks CE ⊕

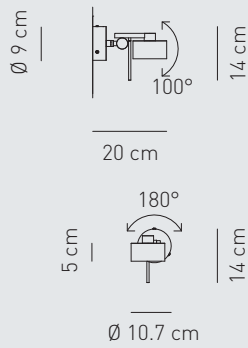

AP AX20 GR

base / bulb type G9 halogen
 power 1 x max 60 w
 ilcos HSGST/C/UB 
 marks CE ⊕

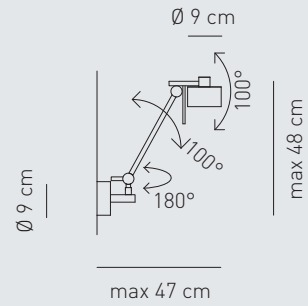

SP AX20 PI

base / bulb type G9 halogen
 power 1 x max 60 w
 ilcos HSGST/C/UB 
 marks CE ⊕

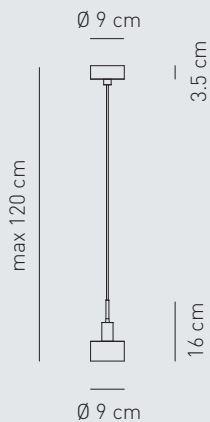

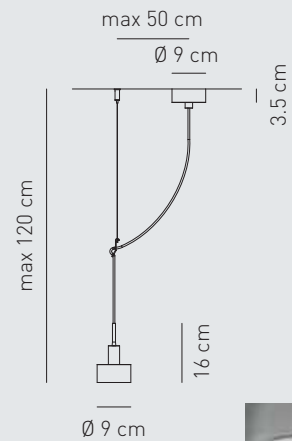

SP AX20 DE

base / bulb type G9 halogen
 power 1 x max 60 w
 ilcos HSGST/C/UB 
 marks CE ⊕



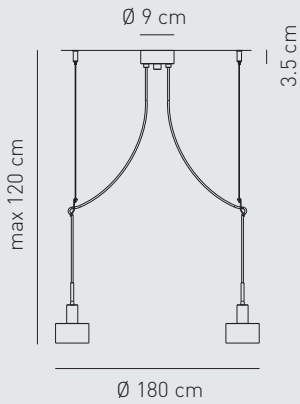

2 X SP AX20 DE

base / bulb type G9 halogen
power 2 x max 60 w
ilcos HSGST/C/UB 
marks CE 



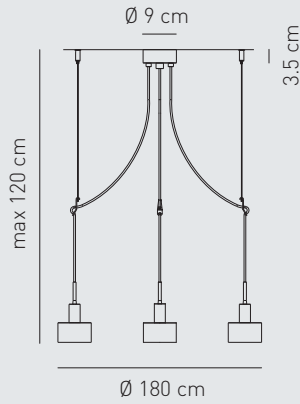

3 X SP AX20 DE

base / bulb type G9 halogen
power 3 x max 60 w
ilcos HSGST/C/UB 
marks CE 



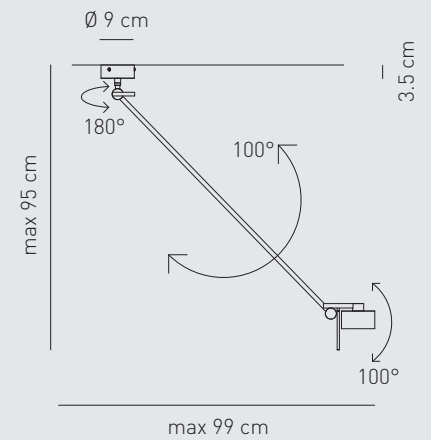

SP AX20 B1

base / bulb type G9 halogen
power 1 x max 60 w
ilcos HSGST/C/UB 
marks CE 



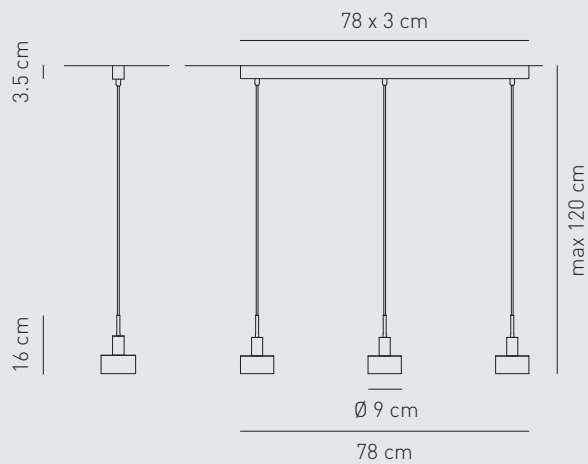

SP AX20 3

base / bulb type G9 halogen
power 3 x max 60 w
ilcos HSGST/C/UB 
marks CE 



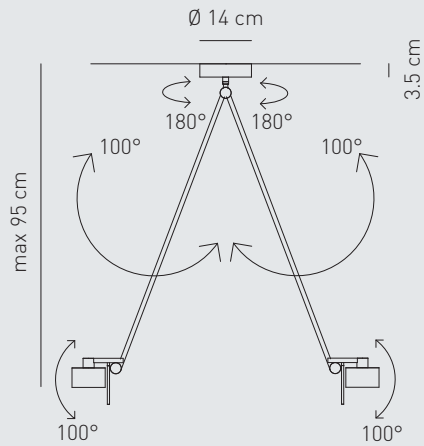

SP AX20 B2

base / bulb type	G9 halogen
power	2 x max 60 w
ilcos	HSGST/C/UB 
marks	CE  



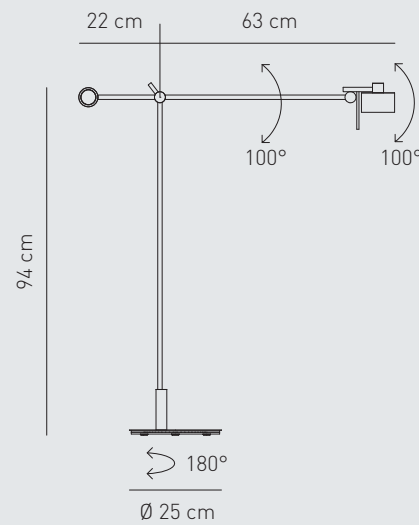

PT AX20

base / bulb type	G9 halogen
power	1 x max 60 w
ilcos	HSGST/C/UB 
marks	CE  



LT AX20

base / bulb type	G9 halogen
power	1 x max 60 w
ilcos	HSGST/C/UB 
marks	CE  

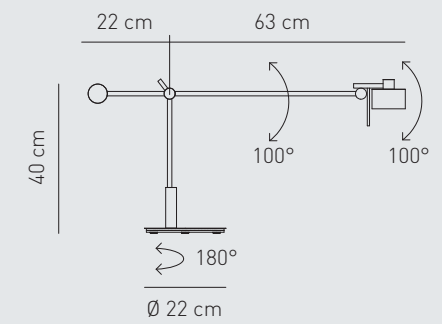



Axo Light si riserva il diritto di apportare ai modelli, senza alcun preavviso, qualsiasi modifica ritenesse opportuna. Axo Light non risponde per eventuali danni a persone o cose causati da una non corretta installazione dei propri apparecchi d'illuminazione.

I dati riportati sono puramente indicativi; è possibile che siano riportati degli errori di stampa.

Axo Light reserves itself the right to introduce any changes to its own models, without prior notice. Axo Light is not liable for injuries or damage due to the incorrect installation of its fixtures. The details given here are intended purely as guidance as errors may have occurred during the printing process.

Axo Light behält sich das Recht vor, jederzeit und ohne Voranmeldung, Änderungen der Kollektion vorzunehmen, ohne jedoch die charakteristischen Eigenschaften der Artikel zu ändern. Axo Light ist nicht verantwortlich für eventuelle Personen- oder Sachschäden, verursacht durch unsachgemäße Installation der Produkte. Aufgrund möglicher Druckfehler, sind die angegebenen Daten lediglich als Richtwerte zu verstehen.

Axo Light se réserve le droit de modifier ses collections à tous moments et sans préavis, dans le respect des caractéristiques de base du produit. Axo Light ne répond pas aux éventuels dommages à personnes ou choses causés par une mauvaise installation de ses appareils d'éclairage. Les coordonnées mentionnées sont purement indicatives; il est possible que des erreurs d'impression y figurent.

Axo Light se reserva el derecho de aportar a los propios modelos, sin ningún preaviso, cualquier modificación que se considere oportuna. Axo Light no responde por los eventuales daños causados a personas o cosas provocados por una incorrecta instalación de los propios aparatos de iluminación. Los datos que aparecen son puramente indicativos; es posible que contengan errores de impresión.

Ахо Light оставляет за собой право вносить модификации моделей без предупреждения, в случае необходимости. Ахо Light не несёт ответственности за ущерб людям или вещам, вызванный некорректной установкой осветительных приборов. Приведенные данные носят иллюстративный характер; возможны опечатки.