



AXO[®] 2011-2012
LIGHT

UKIYO

MANUEL VIVIAN

Collezione di lampade da parete e da soffitto in tessuto ignifugo, sfoderabile, lavabile, e elastico retato a due strati. Disponibile in tre tonalità: fondo bianco e rete bianca, fondo arancio e rete nera, fondo bianco e rete nera.

Wall and ceiling lamp collection made with a special fireproof, removable and washable covering composed of two overlapping elastic fabrics. Available in three shades: white background covered with white netting, orange background with black net on top, white background with black net on top.

Leuchtenkollektion bestehend aus Wand- und Deckenleuchten, bezogen aus elastischem, feuerhemmendem Netz-Technostoff, bestehend aus zwei Stofflagen, der abziehbar und waschbar ist. In drei Farbtönen erhältlich: Grundstoff weiß mit weißem Netz, Grundstoff orange mit schwarzem Netz, Grundstoff weiß und schwarzem Netz.

Collection d'appliques et de plafonniers en tissu technique élastique ignifugeant, amovible, lavable et réticulé à deux couches. Disponible en trois tonalités: fond blanc et résille blanche, fond orange et résille noire, fond blanc et résille noire.

Colección de lámparas de pared y de techo en tejido técnico ignífugo, desfundable, lavable y elástico con retículo de dos capas. Disponible en tres tonalidades: fondo blanco y red blanca, fondo anaranjado y red negra, fondo blanco y red negra.

Коллекция настенных и потолочных светильников из огнестойкой технической эластичной сетчатой двухслойной ткани. Предлагается выбор из трех расцветок: белый фон и белая сетка, оранжевый фон и чёрная сетка, белый фон и чёрная сетка.





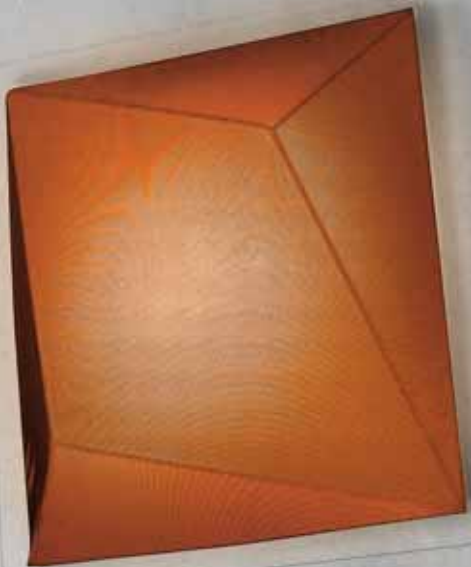
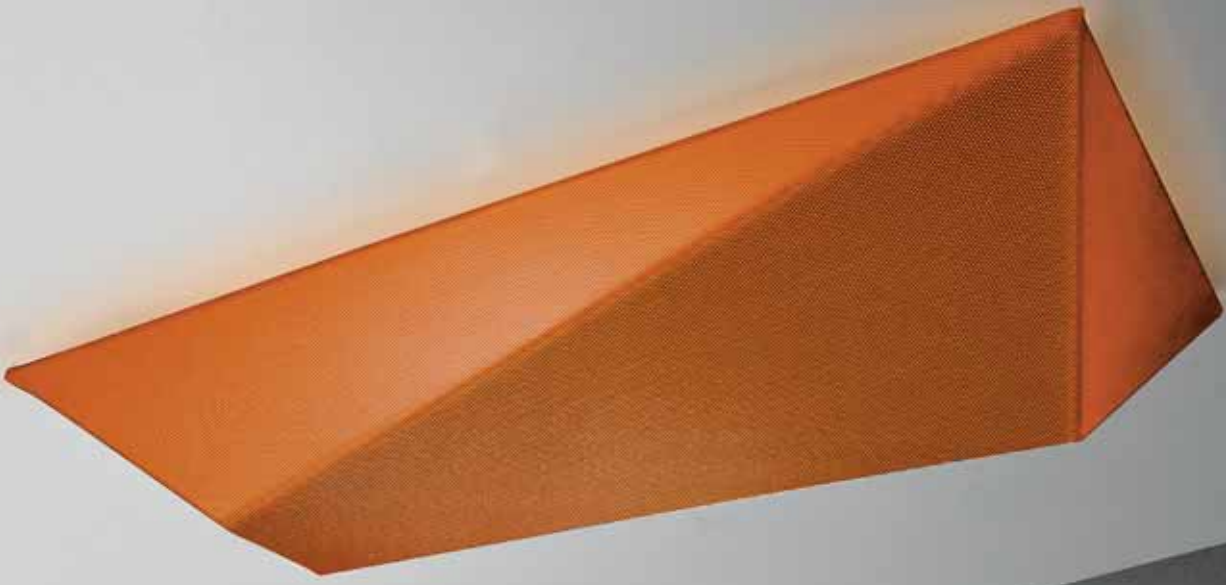





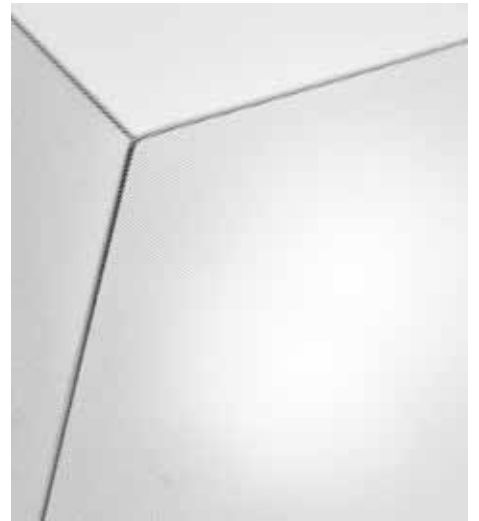























- ^ PL UKI 110
- > PL UKIYO P (DETAIL)
- < PL UKI 110 / PL UKIYO P
- « PG 107: PL UKIYO G / PL UKIYO P
- ✓ PL UKIYO P (DETAIL)



TECHNICAL DATA





-  E27 incandescent
-  E14 incandescent
-  E14 incandescent
-  E27 fluorescent
-  E27 fluorescent globe
-  E27 fluorescent twist
-  E14 fluorescent
-  E14 fluorescent
-  E14 fluorescent
-  E27 fluorescent
-  GX24q-2 fluorescent
-  2GX13 fluorescent
-  2G11 fluorescent
-  G5 fluorescent
-  G24d-2 fluorescent
-  G9 halogen
-  E27 halogen
-  G4 halogen
-  GY 6.35 halogen
-  GU4 halogen
-  GU5.3 halogen
-  GU10 halogen
-  E14 halogen
-  G53 halogen
-  R7s halogen

I nostri prodotti sono tutti sottoposti alle prove di sicurezza elettrica e conformi alle Direttive Comunitarie Europee EN60598-1, LVD 2006/95/EC, EMC 2004/108/EC (ove previsto).

All our products undergo electric safety tests and comply with ECC Directive EN60598-1, LVD 2006/95/EC, EMC 2004/108/EC (where provided).

Entsprechend den Europäischen Normen EN60598-1, LVD 2006/95/EC, EMC 2004/108/EC (sofern vorgesehen), werden alle Produkte den elektrischen Sicherheitsprüfungen unterzogen.

Tous nos produits sont soumis aux tests de sécurité, et sont conformes aux Directives CEE EN60598-1, LVD 2006/95/EC, EMC 2004/108/EC (le cas échéant).

Todos nuestros productos han sido sometidos a las pruebas de seguridad eléctrica y son conformes con las directivas comunitarias europeas EN60598-1, LVD 2006/95/EC, EMC 2004/108/EC (en los casos previstos).

Все наши изделия проходят испытания на электрическую безопасность и соответствуют директивам Европейского Сообщества EN60598-1, LVD 2006/95/EC, EMC 2004/108/EC (в случаях, когда это предусмотрено).



Solo isolamento fondamentale; le parti conduttrici accessibili sono collegate ad un conduttore di terra. Messa a terra obbligatoria.

Basic insulation, accessible conductors are earthed. Earthing is compulsory.

Grundisolation: berührbare Metallteile mit Anschlussstelle für Schutzleiter verbunden. Netzschutzleiter: vorgeschrieben.

Isolation de base: les parties conductrices accessibles sont mises à terre. Mise à terre obligatoire.

Solo aislamiento fundamental; las partes conductoras accesibles están conectadas a un conductor de tierra. Puesta a tierra obligatoria.

Изоляция только базовая. Доступные проводниковые части подсоединены к заземлителю. Заземление обязательно.



Sistema a doppio isolamento;
messa a terra esclusa.

Double insulation. Earthing:
excluded.

Doppelte Isolierung.
Netzschutzleiter: nicht erlaubt.

Double isolation. Mise à la terre:
exclue.

Sistema de doble aislamiento;
puesta a tierra no incluida.

Система двойной изоляции.
Заземление необязательно.



Apparecchio in cui la protezione
contro la scossa elettrica si basa
sulla alimentazione a bassissima
tensione di sicurezza.

Appliance in which protection
against electrical shock is
guaranteed by the extremely
low-voltage power supply.

Zum Schutz vor elektrischen
Schlägen mit Niedervolt Gespeistes
Gerät.

Appareil avec protection contre
les décharges électriques basée
sur l'alimentation à une tension
de sécurité très basse.

Aparado en el qual la protecció
contra la descarga eléctrica se debe
a la alimentació a muy baja
tensió.

Прибор, в котором защита от удара
током основана на питании от
очень низкого напряжения.



Predisposto con variatore di luce.

With dimmer.

Mit Dimmer.

Avec dimmer.

Con dimmer.

Предусмотрено с диммер.

Le schede tecniche dei prodotti
Axo Light sono scaricabili
direttamente dal nostro sito.

Axo Light technical sheets
can be directly downloaded from
our website.

Les fiches techniques des produits
Axo Light peuvent être téléchargés
directement de notre site.



Las fichas técnicas de producto
Axo Light se pueden descargar
directamente de nuestro sitio.



Die Axo Light Produktdatenblätter
können direkt von unserer Website
heruntergeladen werden.

Технические характеристики
изделий фирмы Axo Light
возможно скачать с нашего сайта.

UKIYO WHITE VARNISHED FITTINGS | APPLICATION: BOTH AS CEILING OR WALL LAMP



PL UKIYO P

base / bulb type E27 incandescent
power 3 x max 60 w
ilcos IAA/C 
marks CE 

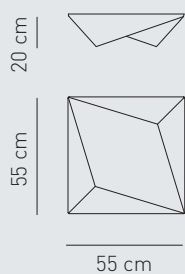
base / bulb type 2GX13 fluorescent
power 1 x 55 w
ilcos FC-55 
marks CE 





PL UKI 110

base / bulb type E27 incandescent
power 3 x max 100 w
ilcos IAA/C 
marks CE 

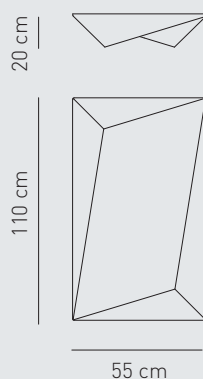
base / bulb type 2GX13 fluorescent
power 1 x 55 w
ilcos FC-55 
marks CE 



PL UKIYO G

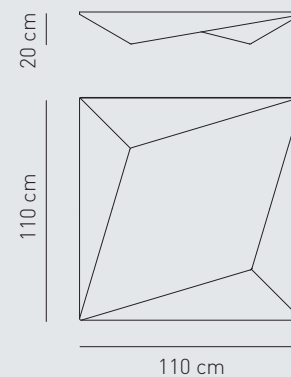

base / bulb type E27 incandescent
power 3 x max 100 w
ilcos IAA/C 
marks CE 

base / bulb type 2GX13 fluorescent
power 1 x 55 w
ilcos FC-55 
marks CE 



URIEL VARNISHED OR CHROME-PLATED FINISHINGS

AP URIEL P

base / bulb type R7s halogen eco
power 1 x max 120 w (78)
ilcos HDG 
marks CE 

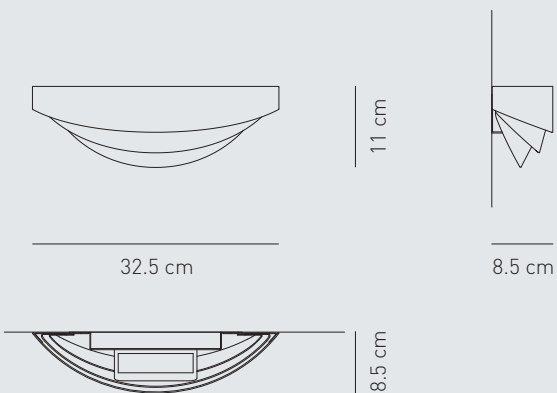



Axo Light si riserva il diritto di apportare ai modelli, senza alcun preavviso, qualsiasi modifica ritenesse opportuna. Axo Light non risponde per eventuali danni a persone o cose causati da una non corretta installazione dei propri apparecchi d'illuminazione.

I dati riportati sono puramente indicativi; è possibile che siano riportati degli errori di stampa.

Axo Light reserves itself the right to introduce any changes to its own models, without prior notice. Axo Light is not liable for injuries or damage due to the incorrect installation of its fixtures. The details given here are intended purely as guidance as errors may have occurred during the printing process.

Axo Light behält sich das Recht vor, jederzeit und ohne Voranmeldung, Änderungen der Kollektion vorzunehmen, ohne jedoch die charakteristischen Eigenschaften der Artikel zu ändern. Axo Light ist nicht verantwortlich für eventuelle Personen- oder Sachschäden, verursacht durch unsachgemäße Installation der Produkte. Aufgrund möglicher Druckfehler, sind die angegebenen Daten lediglich als Richtwerte zu verstehen.

Axo Light se réserve le droit de modifier ses collections à tous moments et sans préavis, dans le respect des caractéristiques de base du produit. Axo Light ne répond pas aux éventuels dommages à personnes ou choses causés par une mauvaise installation de ses appareils d'éclairage. Les coordonnées mentionnées sont purement indicatives; il est possible que des erreurs d'impression y figurent.

Axo Light se reserva el derecho de aportar a los propios modelos, sin ningún preaviso, cualquier modificación que se considere oportuna. Axo Light no responde por los eventuales daños causados a personas o cosas provocados por una incorrecta instalación de los propios aparatos de iluminación. Los datos que aparecen son puramente indicativos; es posible que contengan errores de impresión.

Ахо Light оставляет за собой право вносить модификации моделей без предупреждения, в случае необходимости. Ахо Light не несёт ответственности за ущерб людям или вещам, вызванный некорректной установкой осветительных приборов. Приведенные данные носят иллюстративный характер; возможны опечатки.