

lapalma

kai stool

design shin azumi
2006

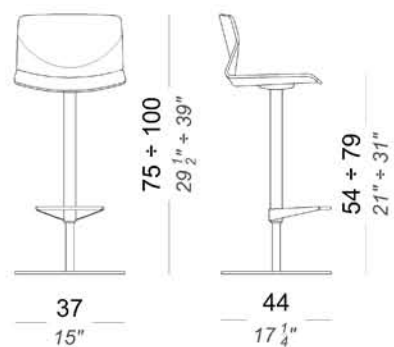



Sgabello girevole ad altezza variabile con molla a gas. Colonna in acciaio inox micropallinato, scocca in multistrati curvato in varie finiture. Cuscino in pelle o tessuti opzionale.

Stool with swivel seat and adjustable height with gas-spring. Sandblasted stainless steel leg and base zinc-plated covered with a stainless steel sheet. Seat in curved plywood; also available with soft leather or fabric seat pad.

 15 kg

 0

test: EN 15373/2007 A.5





Base rivestita in acciaio
inox Aisi 304 con feltri ad-
esivi in lana.

*Aisi 304 stainless steel
base with wool felt*



Blocchetto di unione sedile/colonna in alluminio pressofuso
sabbato e comando della molla a gas in acciaio inox.

*Pivot under the seating in die-cast aluminium and operating
lever in stainless steel*

finiture / finishes



laccato bianco
white lacquered



rovere sbiancato
blached oak



rovere noce scuro
oak dark walnut



tinto nero poro aperto
black open pore



tessuto Highfield 651
Highfield fabric 651



tessuto Highfield 951
Highfield fabric 951



tessuto Highfield 191
Highfield tessuto 191



tessuto Hallingdal 103
Hallingdal fabric 103



tessuto Hallingdal 224
Hallingdal fabric 224



tessuto Hallingdal 674
Hallingdal fabric 674



tessuto Hallingdal 960
Hallingdal fabric 960

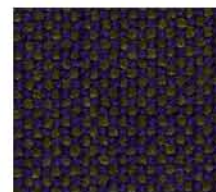

tessuto Hallingdal 968
Hallingdal fabric 968



tessuto Hallingdal 702
Hallingdal fabric 702

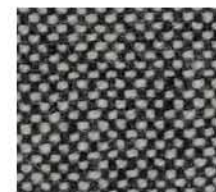

tessuto Hallingdal 126
Hallingdal fabric 126

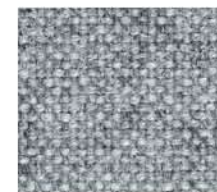

tessuto Hallingdal 130
Hallingdal fabric 130



tessuto Hallingdal 153
Hallingdal fabric 153

finiture / finishes



cuolo bianco
white leather



cuolo grigio
grey leather



cuolo fango
mud leather



cuolo rosso
red leather



cuolo tabacco
tobacco leather



cuolo marrone
dark brown leather

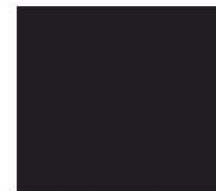

cuolo nero
black leather



pelle bianca
white soft leather



pelle grigio
grey soft leather



pelle fango
mud soft leather

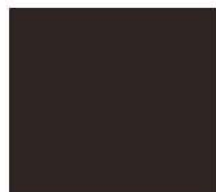

pelle marrone scuro
dark brown soft leather

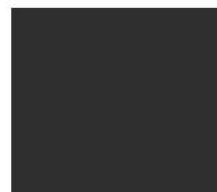

pelle nera
black soft leather



acciaio inox
stainless steel

kai stool

design shin azumi
2006



ISTRUZIONI D'USO E MANUTENZIONE

Pulire tutte le parti in legno, cuoio, tessuto e metallo con un panno umido, o con detergente liquido neutro diluito.

Non usare prodotti a base alcolica, candeggina, solvente o prodotti abrasivi.

Liquidi versati sul prodotto devono essere asciugati subito.

Per sollevare e spostare il prodotto non afferrare solo il sedile, bensì afferrare saldamente la struttura.

Il prodotto non deve essere sottoposto a carichi decentrati, è stato progettato per essere utilizzato in condizioni normali di appoggio (su quattro gambe o sulla base). L'azienda si solleva da ogni responsabilità per eventuali danni provocati su pavimenti delicati o teneri.

Evitare l'uso improprio del prodotto: non salire sul prodotto con i piedi, nè sul poggiatesta o sui braccioli. In particolar modo evitare oscillazioni che potrebbero pregiudicare il funzionamento e la sicurezza dell'utente.

Il legno ed il cuoio sono, per loro natura, facilmente danneggiabili, alcune piccole impurità e imperfezioni rientrano negli standard di qualità accettati.

Non esporre alle intemperie, agli agenti atmosferici né a fonti di calore superiori a 40°C. I prodotti destinati all'uso esterno subiscono comunque nel tempo l'azione degli agenti atmosferici. Eventuali alterazioni superficiali possono verificarsi a specifiche condizioni di esposizione di temperatura, umidità e salinità. Una corretta e frequente manutenzione e pulizia aumentano la durabilità del prodotto.

Il prodotto se è esposto alla luce del sole può essere soggetto a variazioni di colore.

Interventi di manutenzione devono essere eseguiti da personale esperto.

Smaltire l'imballo solo a completamento dell'assemblaggio, onde evitare lo smarrimento di eventuale ferramenta e componenti.

Una volta dimesso, il prodotto od i suoi componenti vanno conferiti ai sistemi pubblici di smaltimento secondo quanto previsto dalla legislazione in vigore.

USE AND MAINTENANCE INSTRUCTIONS

Clean all parts in wood, leather, fabric and metal with a damp cloth or a diluted neutral cleaner.

Do not use cleaners with alcohol, bleach, solvent or abrasive products.

Any liquid spilt on the product must be wiped up immediately.

When lifting or moving the product, hold it on the structure and not under the seat.

The product should not be subjected to unbalanced weights, as it is designed for a proper rest on the foothold (on four legs or on the base). Our company relieves from any responsibility in case of damage caused to fragile floors.

Avoid any improper use of the product: do not step on the product, on the footrest or on the armrests. Avoid any movements that could compromise the proper functionality of the product or the safety of the users.

Wood and leather, being natural materials, could be easily damaged. Small impurities or imperfections are within quality standard range.

Do not expose the product to weather conditions or atmospheric agents, nor to heat sources over 40°C. Also products for outdoor use could be afflicted by atmospheric agents. The product could undergo possible exterior changes due to particular exposure to heat, humidity and saltiness. An appropriate and frequent maintenance and cleaning of the product enhances its durability.

The product could change colour and shade, if exposed to direct sunlight.

Maintenance has to be carried out by experienced staff.

Dispose of the package only after assembling the product, in order to avoid the loss of ironmongery and components.

Once the product has been dismantled, the product itself or its components must be given to the public garbage disposal system, according to the legislation in force.